



**UNIDAD ELECTRÓNICA
ELECTRONIC MONITOR
UNITÉ ÉLECTRONIQUE
ELEKTRONIKEINHEIT
UNIDADE ELECTRÓNICA
IMPIANTO ELETTRONICO**

Fig.1

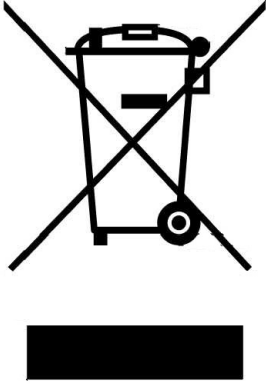

Fig.2

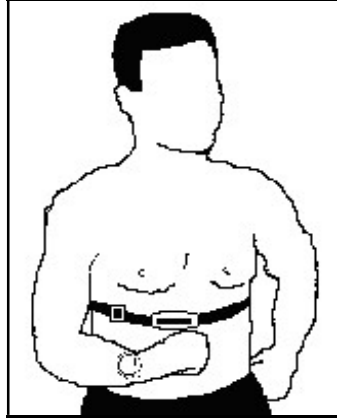

Fig.3

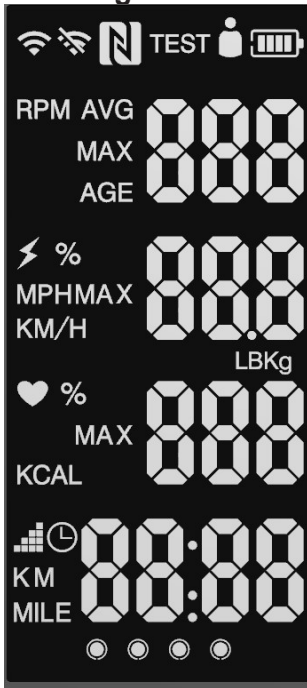

Fig.4

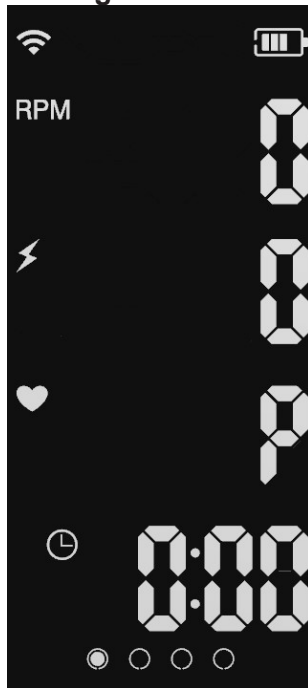

Fig.5

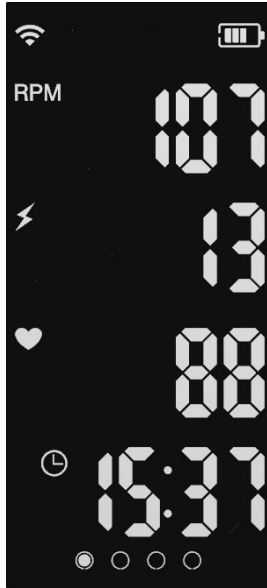

Fig.6

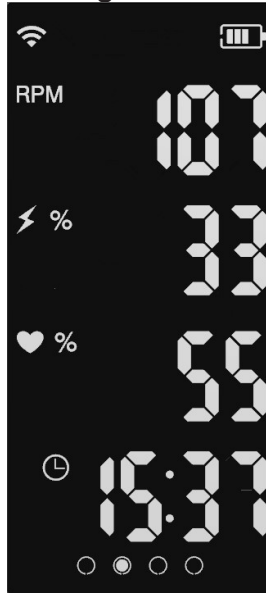

Fig.7



Fig.8

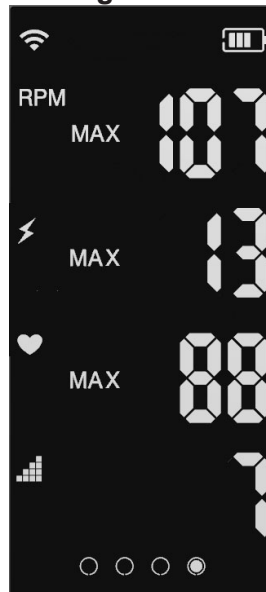

Fig.9

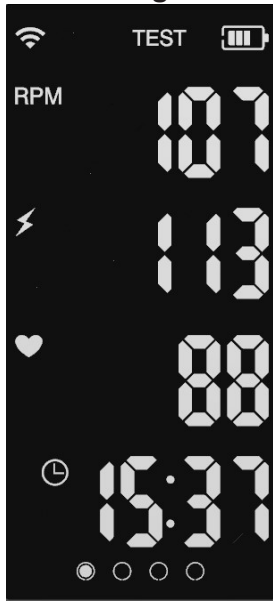

Fig.10

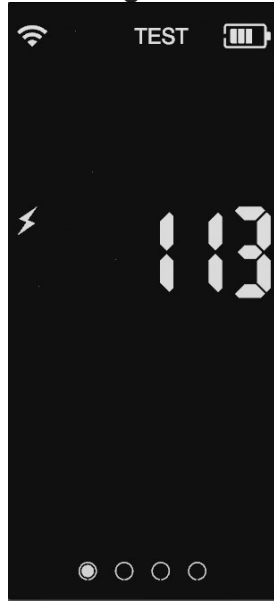

Fig.11

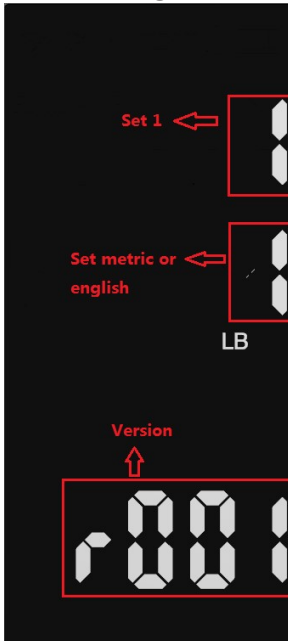

Fig.12

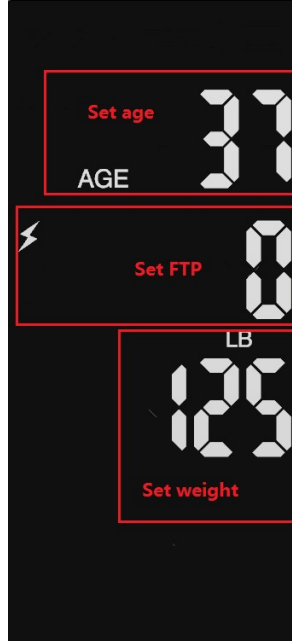
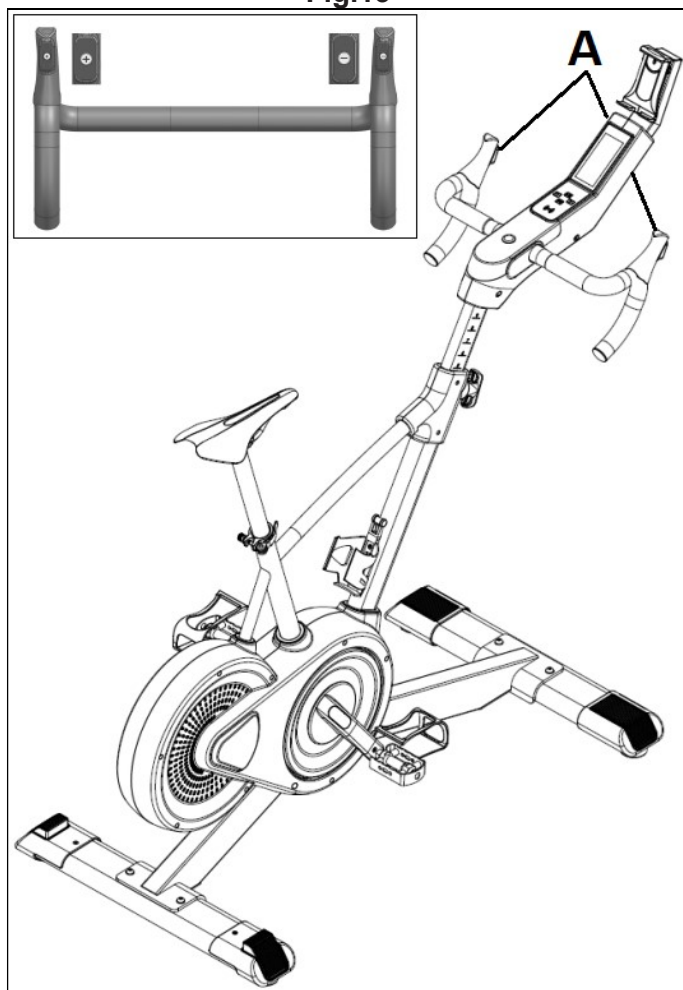

Fig.13



1.-MONITOR ELECTRÓNICO.-

Para hacer más cómodo y simple el control de su ejercicio este electrónico muestra r.p.m, distancia - tiempo de ejercicio, pulso, nivel, vatios - calorías consumidas.

La pantalla se encenderá al comenzar el ejercicio Fig.3 y luego se mostrará en la pantalla de inicio inicial Fig.4.

El monitor se apagará automáticamente cuando la unidad esté 60 segundos parada reseteando los valores de la sesión.

Importante: Deposite los componentes electrónicos en contenedores especiales, Fig.1.

2.- PULSO TELEMÉTRICO.-

Para medir las pulsaciones durante su ejercicio, se necesita la banda medidora de pecho (OPCIONAL). Fig. 2.

Ver libro de instrucciones de pulso telemetrico.

3.- FUNCIONES.-



: Símbolo de conexión



: RPM



: Vatios



: Pulso Cardíaco



: Tiempo



: $(\text{Vatio}/\text{FTP}) * 100$

(Nota: Vatio son los vatios del deporte actual, y FTP está configurado en modo de ingeniería 2.)



: $(\text{Pulso} / (220 - \text{Año})) * 100$

(Nota: Pulso Cardíaco es el valor del pulso Cardíaco del deporte actual, y Año se establece en el modo de ingeniería 2.))



: RPM Medio



: Velocidad (métrico)



: Calorías



: Distancia



MAX

: Velocidad Máxima



MAX

: Vatio Máximo





MAX

: Pulso Cardíaco Máximo



: Nivel

4.- FUNCIONAMIENTO.-

Presione las teclas  o  para cambiar entre las 4 pantallas disponibles, Fig.5, Fig. 6, Fig.7 y Fig. 8.

Presione la tecla  para comenzar el ejercicio. Presione de nuevo para pausarlo.

Presione las teclas  y  del monitor o del manillar (Fig.13) para cambiar el nivel del ejercicio.

Presione la tecla  para realizar el test y obtener su nivel FTP.

5.- TEST FTP.-

Una vez presionada la tecla  aparecerá en la parte superior de la pantalla la palabra TEST, Fig.9.

El test se desarrollará en 3 fases:
 Fase 1: calentamiento de 2 minutos.
 Fase 2: prueba de 14 minutos.
 Fase 3: Sprint de 4 minutos.
 Durante los últimos 10 segundos de cada fase, la palabra TEST y el tiempo parpadearán.

Una vez completado el test, le aparecerá en pantalla el valor FTP, Fig.10.



El valor FTP (Functional Threshold Power) corresponde con la potencia que un usuario puede desarrollar durante 45 - 60 minutos. Constituye una buena referencia para determinar las zonas de trabajo de acuerdo a la siguiente tabla:

zona	 %
Recuperación	<55%
Resistencia	55% – 74%
Ritmo	75% – 89%
Umbral lactato	90% – 104%
VO2	105% – 120%
Límite anaerobico	>120%



Si el valor de FTP es 0 las zonas se determinan en función de los wattios:

zona	WATT
Recuperación	0-99
Resistencia	100-199
Ritmo	200-299
Umbral lactato	300-399
VO2	400-499
Límite anaerobico	≥500

6.- CAMBIO DE UNIDADES INGLÉS-MÉTRICO.-

Con el monitor encendido presione las teclas  y  durante 3 segundos para acceder a la Fig.11.

Presione la tecla  para confirmar y cambiar de valor.



Presione las teclas  o  para ajustar el valor.

En la parte intermedia introduzca las unidades (0-> métrico; 1-> inglés). La parte inferior muestra la versión del software.



Una vez introducidos los valores, presione la tecla  durante 3 segundos para guardar la

configuración y salga a la pantalla inicial.

7.- INTRODUCCIÓN DE DATOS.-

Con el monitor encendido presione las teclas  y  durante 3 segundos para acceder a la Fig.12.

Presione la tecla  para confirmar y cambiar de valor.

Presione las teclas  o  para ajustar el valor.

En la parte superior introduzca su edad.

En la parte intermedia introduzca el valor de su FTP. (0 si quiere trabajar por watos)

En la parte inferior introduzca su peso.

Una vez introducidos los valores,

presione la tecla  durante 3 segundos para guardar la configuración y salga a la pantalla inicial.

FUNCIONAMIENTO iOS (iPod Touch/iPhone/iPad).-

Este monitor dispone de un módulo Bluetooth integrado.

Active la función Bluetooth en el iPod/iPhone/iPad.

A continuación descargue una aplicación compatible con el protocolo FTMS (ZWIFT, KINOMAP,...) de Apple Store y ejecútela.

Cuando la aplicación lo requiera

seleccione su módulo BH de la lista de dispositivos para vincularlo.

FUNCIONAMIENTO CON DISPOSITIVOS ANDROID.-

Este monitor dispone de un módulo Bluetooth integrado.

Active la función Bluetooth en el dispositivo Android.

A continuación descargue una aplicación compatible con el protocolo FTMS (ZWIFT, KINOMAP,...) de Google Play y ejecútela.

Cuando la aplicación lo requiera seleccione su módulo BH de la lista de dispositivos para vincularlo.

Nota: El monitor tiene que estar mostrando datos para conectarse.

Pedalee y presione la tecla  para comenzar el ejercicio.

Consulte Apps compatibles en la web: www.bhfitness.com

Consiga su código de activación gratuito BH by Kinomap en:

<http://colectivos.bhonlinestore.com/bh-by-kinomap/>

Para cualquier consulta, no dude en ponerse en contacto con el (S.A.T).Servicio de Asistencia Técnica, llamando al teléfono de atención al cliente (ver página final del presente manual).

BH SE RESERVA EL DERECHO A MODIFICAR LAS ESPECIFICACIONES DE SUS PRODUCTOS SIN PREVIO AVISO.

English

1.-ELECTRONIC MONITOR.-

To make your exercise control more comfortable and simple this electronic displays r.p.m, distance - exercise time, pulse, level, watts - calories consumed.

The screen will turn on at the beginning of the exercise Fig. 3 and then it will be shown on the initial home screen Fig. 4.

The monitor will turn off automatically when the unit is 60 seconds stopped which resetting the session values.

Important: Deposit the electronic components in special containers, Fig. 1.

2.- TELEMETRIC PULSE.-

To measure the pulsations during your exercise, you need the chest measuring band (OPTIONAL). Fig. 2.

See telemetry pulse instruction book.

3.- FUNCTIONS.-



: connection display symbol



: RPM



: WATT



: PULSE



: Time



: $(\text{WATT}/\text{FTP}) * 100$

(Note: WATT is the watts of current sport, and FTP is set into engineering mode 2.)



: $(\text{PULSE}/(220-\text{AGE})) * 100$

(Note: PULSE is the heartbeat value of the current sport, and AGE is set into engineering mode 2.)



: Average RPM



: SPEED (metric)



: CALORIES



: DISTANCE

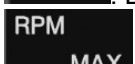

: Maximum SPEED

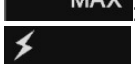

: Maximum WATT





: Maximum PULSE



: LEVEL

4.- OPERATION.-

Press the keys  or  to switch between the 4 available screens, Fig. 5, Fig. 6, Fig. 7 and Fig. 8.

Press the key  to start the exercise. Press again to pause it.

Press the keys  or  on the monitor or on the handlebar (Fig.13) to change the intensity.

Press the key  to perform the test and get your FTP level.

5.- TEST FTP.-

Once the key  is pressed, the word TEST will appear at the top of the screen, Fig. 9.

The test will take place in 3 phases:

Phase 1: 2 minute warm up.

Phase 2: 14 minute test.

Phase 3: 4-minute sprint.

During the last 10 seconds of each phase, the word TEST and the time will flash.

Once the test is complete, the FTP value will appear on the screen, Fig. 10.

The FTP (Functional Threshold Power) value corresponds to the power that a user can develop for 45-60 minutes. It constitutes a good reference to determine the work zones according to the following table:



zone	 %
Recovery	<55%
Resistance	55% – 74%
Rhythm	75% – 89%
Lactate threshold	90% – 104%
VO2	105% – 120%
Anaerobic limit	>120%

If the FTP value is 0 the zones are determined based on watts:

zone	WATT
Recovery	0-99
Resistance	100-199
Rhythm	200-299
Lactate threshold	300-399
VO2	400-499
Anaerobic limit	≥500

6.- CHANGE OF ENGLISH-METRIC UNITS.-

With the monitor on, press the keys

 and  for 3 seconds to access Fig. 11.

Press the key  to confirm and change value.

Press the keys  or  to adjust the value.

In the middle, enter the units (0-> metric; 1-> English).

The lower part shows the software version.

Once the values have been entered, press the key  for 3 seconds to save the settings and exit to the initial screen.

7.- DATA INTRODUCTION.-

With the monitor on, press the keys



for 3 seconds to access the setting screen. Fig. 12.

Press the key  to confirm and change value.

Press the keys  or  to adjust the value.

At the top enter your age.

En la parte intermedia introduzca el valor de su FTP. (0 si quiere trabajar por watos)

En la parte inferior introduzca su peso. Once the values have been entered,

press the key  for 3 seconds to save the settings and exit to the initial screen.

iOS OPERATION (compatible iPhone, iPad and iPod Touch).-

This monitor has an integrated Bluetooth module.

Turn Bluetooth to "ON" in settings on the iOS device.

Download an App that supports the FTMS protocol from the App Store (ZWIFT, KINOMAP,...).

Open the App to run it. When prompted by the App, select the appropriate BH Module from the list displayed on the device to pair.

ANDROID OPERATION (compatible Android devices).-

This monitor has an integrated Bluetooth module.

Turn Bluetooth to "ON" in settings on the Android device.

Download an App that supports the FTMS protocol from Google Play (ZWIFT, KINOMAP,...).

Open the App to run it. When prompted by the App, select the appropriate BH Module from the list displayed on the Android device to pair.

Note: The monitor must be ON to be detected for connecting.

Pedal and press the key  to begin the exercise.

See compatible Apps on the web:
www.bhfitness.com

Get your free BH by Kinomap activation code at:

<http://colectivos.bhonlinestore.com/bh-by-kinomap/>

Do not hesitate to get touch with the Technical Assistance Service if you have any queries by phoning customer services (see last page in manual)

BH RESERVES THE RIGHT TO MODIFY THE SPECIFICATIONS OF ITS PRODUCTS WITHOUT PRIOR NOTICE

Français

1.- UNITÉ ÉLECTRONIQUE.-

Pour rendre le contrôle de votre exercice plus confortable et plus simple, cet électronique affiche le rpm, la distance - temps d'exercice, pouls, niveau, watts - calories consommées.

L'écran s'allumera lorsque vous commencerez l'exercice Fig. 3, puis il s'affichera dans l'écran d'accueil initial Fig. 4.

Le moniteur s'éteindra automatiquement lorsque l'unité est arrêtée pendant 60 secondes, réinitialisant les valeurs de la session.

Remarque importante: Les composants électroniques hors d'usage doivent être déposés dans des conteneurs spécialement prévus à cet effet. Fig.1.

2.- POULS TÉLÉMÉTRIQUE.-

Pour mesurer votre fréquence cardiaque pendant votre exercice, vous avez besoin de la bande thoracique(EN OPTION). Figure 2.

Voir le manuel d'instructions du pouls télémétrique.

3.- FONCTIONS.-



: Symbole de connexion



: RPM



: Watts



: Pouls cardiaque



: Temps



: (Watt/FTP) *100

(Remarque : Watt correspond aux watts sportifs actuels et FTP est défini sur le mode d'ingénierie 2.)



: (Pouls / (220 - Année)) *100

(Remarque : la fréquence cardiaque est la valeur de fréquence cardiaque du sport actuel et l'année est définie en mode d'ingénierie 2)



: RPM moyen

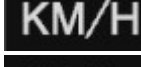

: Vitesse (métrique)

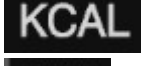

: CALORIES



: Distance

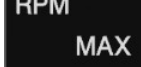

: Vitesse maximal



: Watts maximal



: Pouls cardiaque maximal



: Niveau

4.- OPÉRATIONS.-

Appuyez sur les touches  ou





pour basculer entre les 4 écrans

disponibles, Fig. 5, Fig. 6, Fig. 7 et Fig. 8.

Appuyez sur la touche  pour démarrer l'exercice. Appuyez à nouveau pour le mettre en pause.

Appuyez sur les touches  et

 du moniteur ou du guidon (Fig. 13) pour modifier le niveau d'exercice.

Appuyez sur la touche  pour effectuer le test et obtenir votre FTP.

5.- ESSAI FTP.-

Une fois la touche enfoncée, le mot  apparaîtra en haut de l'écran, Fig. 9.

Le test sera développé en 3 phases :
Phase 1 : échauffement de 2 minutes.
Phase 2 : 14 minutes d'essai.
Phase 3 : Sprint de 4 minutes.
Pendant les 10 dernières secondes de chaque phase, le mot TEST et l'heure clignoteront.

Une fois le test terminé, la valeur FTP apparaîtra à l'écran, Fig. 10.



La valeur FTP (Functional Threshold Power) correspond à la puissance qu'un utilisateur peut développer pendant 45 à 60 minutes. C'est une bonne référence pour déterminer les zones de travail selon les tableau:

zone	 %
Recuperation	<55%
Résistance	55% – 74%
Rythme	75% – 89%
.- ESSAI FTP.-	.- ESSAI FTP.-
VO2	105% – 120%
Limite anaerobyque	>120%



Si la valeur FTP est 0, les zones sont déterminées en fonction des watts:

zone	WATT
Recuperation	0-99
Résistance	100-199
Rythme	200-299
	300-399
Seuil de lactate	
VO2	400-499
Limite anaerobyque	≥500

6.- CHANGEMENT DES UNITES ANGLAIS-METRIQUES.-

Moniteur allumé, appuyez sur les touches  et  pendant 3 secondes pour accéder à la Fig. 11.

Appuyez sur la touche  pour confirmer et modifier la valeur.



Appuyez sur les touches  ou  pour ajuster la valeur.

Au milieu, entrez les unités (0-> métrique ; 1-> anglais).



La partie inférieure affiche la version du logiciel.

Une fois les valeurs saisies, appuyez sur la touche  pendant 3 secondes pour enregistrer les paramètres et revenir à l'écran initial.

7.- PRÉSENTATION DES DONNÉES.-

Moniteur allumé, appuyez sur les touches  et  pendant 3 secondes pour accéder à la Fig. 12.

Appuyez sur la touche  pour confirmer et modifier la valeur.

Appuyez sur les touches  ou  pour ajuster la valeur.

En haut, entrez votre âge.

Au milieu, entrez la valeur de votre FTP. (0 si vous voulez travailler en watts)

En bas, entrez votre poids.

Une fois les valeurs saisies, appuyez sur la touche  pendant 3 secondes pour enregistrer les paramètres et revenir à l'écran initial.

FONCTIONNEMENT IOS (IPOD TOUCH / IPHONE / IPAD).-

Ce moniteur est doté d'un module Bluetooth intégré.

Activez alors la fonction Bluetooth de votre IPOD/IPAD/IPHONE.

Téléchargez ensuite une application compatible avec le protocole FTMS (ZWIFT, KINOMAP,...) via Apple Store et exécutez-la. Lorsque l'application vous le demande,

sélectionnez votre module BH dans la liste des dispositifs pour les relier.

FONCTIONNEMENT AVEC DISPOSITIFS ANDROID.-

Ce moniteur est doté d'un module Bluetooth intégré.

Activez alors la fonction Bluetooth de votre dispositif ANDROID.

Téléchargez ensuite une application compatible avec le protocole FTMS (ZWIFT, KINOMAP,...) via Google Play et exécutez-la. Lorsque l'application vous le demande, sélectionnez votre module BH dans la liste des dispositifs pour les relier.

Remarque: le moniteur doit afficher des données pour se connecter.

Pédalez et appuyez sur la touche  pour démarrer l'exercice

Voir les applications compatibles sur le Web:

www.bhfitness.com

Obtenez votre code d'activation BH by Kinomap gratuit sur:

<http://colectivos.bhonlinestore.com/bh-by-kinomap/>

Pour toute information complémentaire et en cas de doute sur le bon état de l'une quelconque partie de la machine, n'hésitez pas à appeler le Service d'Assistance Technique (SAT) au numéro de téléphone d'Assistance Clientèle qui figure à la dernière page de cette notice.

BH SE RÉSERVE LE DROIT DE MODIFIER LES CARACTÉRISTIQUES DE SES PRODUITS SANS PRÉAVIS.

Deutsch

1.-ELEKTRISCHER MONITOR.-

Um Ihre Trainingskontrolle noch komfortabler und einfacher zu gestalten, zeigt diese elektronische Anzeige Drehzahl, Distanz - Trainingszeit, Puls, Stufe, Watt - verbrauchte Kalorien an.

Der Bildschirm wird zu Beginn der Übung eingeschaltet Fig. 3 und dann wird es auf dem Startbildschirm angezeigt. Fig. 4.

Der Monitor schaltet sich automatisch aus, wenn das Gerät nach 60 Sekunden das Zurücksetzen der Sitzungswerte beendet.

Wichtig: Bewahren Sie die elektronischen Komponenten in speziellen Behälter auf, Fig. 1.

2.- TELEMETRISCHER PULS.-

Um die Pulsationen während des Trainings zu messen, benötigen Sie das Brustmessband (OPTIONAL). Fig. 2.

Siehe Anleitung für Telemetrieimpulse.

3.- FUNKTIONEN.-



: Verbindungssymbol



: RPM



: WATT



: Herzpuls



: Zeit



: (Watt / FTP) * 100

(Hinweis: Watt ist der Wert (Watt) des aktuellen Sports und FTP ist im Engineering-Modus 2 konfiguriert.)



: (Puls / (220-Jahr)) * 100

(Hinweis: Der Herzpuls, ist der Herzimpulswert der aktuellen Sportart und das Jahr ist auf Engineering-Modus 2 eingestellt.)



: RPM Medium



: Geschwindigkeit

(metrisch)



: Kalorien



: Distanz



: Maximale

Geschwindigkeit



: Maximaler Wattwert





: Maximaler Herzpuls



: Stufe

4.- FUNKTION.-

Drücken Sie die Taste  oder  um zwischen den 4 verfügbaren Bildschirmen (Fig. 5, Fig. 6, Fig. 7 und Fig. 8) zu wechseln.

Drücken Sie die Taste  Um die Übung zu beginnen. Drücken Sie erneut, um die Wiedergabe anzuhalten.

Drücken Sie die  und  Tasten am Monitor oder am Lenker (Fig.13), um die Stufe zu ändern.

Drücken Sie die Taste  um den Test durchzuführen und Ihre FTP-Niveau zu erhalten.

5.- TEST FTP.-

Sobald Sie die Taste  drücken, erscheint das Wort TEST, oben auf dem Bildschirm, Fig. 9.

Der Test wird in 3 Phasen durchgeführt:

Phase 1: 2 Minuten aufwärmen

Phase 2: 14 Minuten Test

Phase 3: 4-Minuten-Sprint

Während der letzten 10 Sekunden jeder Phase blinken die Wörter, TEST und die Uhrzeit.

Nach Abschluss des Tests wird der FTP-Wert auf dem Bildschirm angezeigt (Fig. 10).

Der FTP-Wert (Functional Threshold Power) entspricht der Leistung, die ein Benutzer für 45-60 Minuten entwickeln kann. Es ist eine gute Referenz, um die Arbeitsbereiche gemäß der folgenden Tabelle zu bestimmen:



Zone	 %
Erholung	<55%
Widerstand	55% – 74%
Rhythmus	75% – 89%
Laktatschwelle	90% – 104%
VO2	105% – 120%
Anaerobe Grenze	>120%

Wenn der FTP-Wert 0 ist, werden die Zonen basierend auf Watt bestimmt:



Zone	WATT
Erholung	0-99
Widerstand	100-199
Rhythmus	200-299
Laktatschwelle	300-399
VO2	400-499
Anaerobe Grenze	≥500

6.- ÄNDERUNG DER ENGLISCH-METRISCHEN EINHEITEN.-

Drücken Sie mit eingeschaltetem

Monitor die Tasten  und  3 Sekunden lang gedrückt halten, um auf Fig. 11 zuzugreifen.

Drücken Sie die Taste  um den Wert zu bestätigen und zu ändern.

Drücken Sie die Taste  oder  um den Wert anzupassen.



Im obren Teil, muss der Wert auf "1" gesetzt werden. Geben Sie in der Mitte die Einheiten ein (0-> metrisch; 1<> englisch). Der untere Teil, zieht die Softwareversion.

Nachdem Sie die Wete eingegeben



haben, halten Sie die Taste  3 Sekunden Lang gedrückt, um die Einstellungen zu speichern und zum Startbildschirm zurückzukehren.

7.- DATENEINGABE.-

Mit dem eingeschalteten Bildschirm,

halten Sie die Taste  und die  3 Sekunden lang gedrückt, um auf Fig. 12 zuzugreifen.

Drücken Sie die Taste  um den Wert zu bestätigen oder zu ändern.

Drücken Sie die Taste  oder  um den Wert zu bestellen.

Geben Sie oben Ihr Alter ein. In der Mitte geben Sie den Wert Ihres FTP ein. (0 wenn Sie für Watt arbeiten möchten) Geben Sie unten Ihr Gewicht ein.

Nachdem Sie die Werte eingegeben

haben, halten Sie die Taste  3 Sekunden lang gedrückt, um die Einstellungen zu speichern und zum Startbildschirm zurückzukehren.

BETRIEB mit iOS (iPod Touch / iPhone / iPad).-

Dieses Gerät verfügt über eine

integrierte Bluetooth-Modul.

Aktivieren Sie die Bluetooth-Funktion des iPod / iPhone / iPad's. Laden Sie dann eine mit dem FTMS-Protokoll kompatible Anwendung (ZWIFT, KINOMAP,...) aus Apple Store runter und führen Sie sie aus. Wenn die Anwendung Ihnen es erfordert wählen Sie Ihren BH Modul aus der Liste der Geräte um sie zu verknüpfen.

BETRIEB mit Android-Geräte.-

Dieses Gerät verfügt über eine integrierte Bluetooth-Modul.

Aktivieren Sie die Bluetooth-Funktion des Android-Gerätes.

Laden Sie dann eine mit dem FTMS-Protokoll kompatible Anwendung (ZWIFT, KINOMAP,...) aus Google Play runter und führen Sie sie aus.

Wenn die Anwendung Ihnen es erfordert wählen Sie Ihren BH Modul aus der Liste der Geräte um sie zu verknüpfen.

Hinweis: Der Monitor muss eingeschaltet sein, um eine Verbindung herzustellen.

Treten Sie in die Pedale und

drücken Sie die Taste , um die Übung zu beginnen.

Siehe kompatible Apps im Web:
www.bhfitness.com

Holen Sie sich Ihren kostenlosen Aktivierungscode für BH by Kinomap unter:

<http://colectivos.bhonlinestore.com/bh-by-kinomap/>

Bei Fragen wenden Sie sich bitte an den technischen Kundendienst (S.A.T.), indem Sie unter der Kundendiensttelefonnummer anrufen (siehe letzte Seite dieses Handbuchs).

BH BEHÄLT SICH DAS RECHT VOR, DIE SPEZIFIKATIONEN SEINER PRODUKTE OHNE VORHERIGE ANKÜNDUNG ZU ÄNDERN.

1.-MONITOR ELECTRÓNICO.-

Para um treino mais cómodo e simples este monitor electrónico disponibiliza informação sobre: r.p.m, distância, tempo de treino, pulso, nível, watts, calorias consumidas.

O monitor liga-se ao iniciar o exercício Fig.3 e de seguida aparecerá no monitor a Fig.4.

O monitor desliga-se automaticamente quando o equipamento estiver parado durante 60 segundos fazendo o reset dos valores do treino.

Importante: Deposite os componentes electrónicos em contentores especiais, Fig.1.

2.- PULSO TELEMÉTRICO.-

Para medir as pulsações durante o treino, necessita uma banda de peito (OPCIONAL). Fig. 2.

Ver manual de instruções de pulso telemétrico.

3.- FUNÇÕES.-



: símbolo de conexão



: RPM



: Watts



: Pulso Cardíaco



: Tempo



: $(\text{Watts}/\text{FTP}) * 100$

(Nota: Watts são os watts do desporto atual, e FTP está configurado no modo de engenharia 2)



: $(\text{Pulso} / (220 - \text{Ano})) * 100$

(Nota: Pulso Cardíaco é o valor do pulso cardíaco do desporto atual, e o Ano estabelece-se no modo de engenharia 2)



: RPM Médio



: Velocidade (métrico)



: Calorias



: Distância



MAX

: Velocidade Máxima



MAX

: Watts Máximo

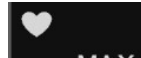

MAX

: Pulso Cardíaco Máximo





: Nível

4.- FUNCIONAMENTO.-

Pressione as teclas ou para mudar entre os 4 ecrãs disponíveis: Fig.5, Fig. 6, Fig.7 y Fig. 8.

Carregue na tecla  para começar o treino. Carregue de novo para pausar.

Pressione as teclas  e  do monitor ou do guiador (Fig.13) para mudar o nível do exercício.

Pressione a tecla  para realizar o teste e obter o seu nível FTP.

5.- TESTE FTP.-

Uma vez pressionada a tecla  aparecerá na parte superior do ecrã a palavra TEST, Fig.9.

O teste desenvolve-se em 3 fases:

Fase 1: Aquecimento de 2 minutos.

Fase 2: Prova de 14 minutos.

Fase 3: Sprint de 4 minutos.

Durante os últimos 10 segundos de cada fase, a palavra TEST e o tempo ficarão a piscar.

Depois do teste completo, aparecerá no ecrã o valor FTP, Fig.10.



O valor FTP (Functional Threshold Power) corresponde à potência que o utilizador pode desenvolver durante 45 - 60 minutos. Constitui uma boa referência para determinar as zonas de treino de acordo com a seguinte tabela:

Zona	 %
Recuperação	<55%
Resistência	55% – 74%
Ritmo	75% – 89%
Limite Lactato	90% – 104%
VO2	105% – 120%
Limite Anaeróbico	>120%



Se o valor de FTP é 0 as zonas determinam-se em função dos watts:

Zona	WATT
Recuperação	0-99
Resistência	100-199
Ritmo	200-299
Limite Lactato	300-399
VO2	400-499
Limite anaeróbico	≥500

6.- MUDANÇA DE UNIDADES INGLÊS-MÉTRICO.-

Com o monitor ligado pressione as teclas  e  durante 3 segundos para aparecer a Fig.11.

Pressione a tecla  para confirmar e mudar de valor.



Pressione as teclas  ou  para ajustar o valor.

Na zona intermédia coloque as unidades (0-> métrico; 1-> inglês).



A zona inferior mostra a versão do software.

Depois de colocados os valores, carregue na tecla  durante 3 segundos para guardar a configuração e saia para o ecrã inicial.

7.- INTRODUÇÃO DE DADOS.-

Com o monitor ligado pressione as teclas  e  durante 3 segundos para aparecer a Fig.12.

Pressione a tecla  para confirmar e alterar o valor.

Pressione as teclas  ou  para ajustar o valor.

Na zona superior coloque a sua idade.

Na zona intermédia coloque o valor do seu FTP. (0 se quer um treino por watts)

Na zona inferior coloque o seu peso. Uma vez introduzidos todos os

valores, pressione a tecla  durante 3 segundos para guardar a configuração e saia para o ecrã inicial.

FUNCIONAMENTO IOS (iPod Touch/iPhone/iPad).-

Este monitor possui um módulo integrado Bluetooth.

Active a função de Bluetooth no iPod/iPhone/iPad.

De seguida descarregue uma aplicação compatível com o protocolo FTMS (ZWIFT, KINOMAP,...) da Apple Store e execute-a.

Quando a aplicação pedir seleccione o seu módulo BH da lista de dispositivos para poder emparelhar.

FUNCIONAMENTO COM DISPOSITIVO ANDROID.-

Este monitor possui um módulo integrado Bluetooth.

Active a função de Bluetooth com o dispositivo Android. De seguida descarregue uma aplicação compatível com o protocolo FTMS (ZWIFT, KINOMAP,...) do Google Play e execute-a.

Quando a aplicação pedir seleccione o seu módulo BH da lista de dispositivos para poder emparelhar.

Nota: O monitor tem que estar a mostrar os dados para se conseguir conectar.

Pedale e pressione a tecla  para començar o treino.

Veja aplicativos compatíveis na Web:

www.bhfitness.com

Obtenha o código de ativação BH by Kinomap gratuito em:

<http://colectivos.bhonlinestore.com/bh-by-kinomap/>

Para qualquer consulta, não hesite em contactar com o S.A.T - Serviço de Assistência Técnica - , telefonando para o serviço de apoio ao cliente (ver página final do presente manual).

BH FITNESS RESERVA O DIREITO DE PODER MODIFICAR AS ESPECIFICAÇÕES DOS SEUS EQUIPAMENTOS SEM AVISO PRÉVIO.

1.- IMPIANTO ELETTRONICO.-

Per rendere il controllo del tuo esercizio più comodo e semplice, questo elettronico mostra r.p.m., distanza - tempo di allenamento, polso, livello, watt - calorie consumate.

Lo schermo si accenderà automatica-mente quando si comincia l'esercizio Fig.3 e dopo verrà indicata sulla schermata iniziale Fig.4.

Il monitor si spegne automaticamente quando l'unità viene ferma per 60 secondi reimpostando i valori della sessione.

Importante: Depositare i componenti elettronici negli appositi contenitori speciali, Fig.1.

2.- PULSO TELEMÉTRICO.-

Per misurare la frequenza cardiaca durante l'esercizio è necessaria la fascia toracica (OPZIONALE), Fig. 2.

Vedere il libretto di istruzioni per la banda di impulsi telemetrica.

3.- FUNZIONI.-



: símbolo di connessione



: RPM



: WATTS



: Pulsazioni



: Tempo



: $(\text{Watts}/\text{FTP}) * 100$

(Nota: Watts si intende per Watts dello sport attuale e FTP è configurato in modalità ingegneria 2)



: $(\text{Pulsazioni} / (220 -$

$\text{Anno})) * 100$

(Nota: Pulsazioni cardiache è il valore delle pulsazioni dello sport attuale, e l'anno si stabilisce in modo ingegneria 2.)



: RPM Medi



: Velocità (metrico)



: Calorie



: Distanza

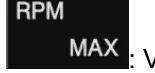

: Velocità Massima

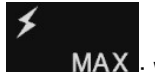

: Watts Massimi





: Pulsazioni cardiache



: Livello

4.- FUNZIONAMENTO.-

Premere il tasto  o  per cambiare tra le 4 schermate disponibili, Fig.5, Fig. 6, Fig.7 y Fig. 8.

Premere il tasto  per iniziare l'esercizio. Premere di nuovo per metterlo in pausa.

Premere i tasti  e  sul monitor o sul manubrio (Fig. 13) per modificare il livello.

Premere il tasto  per realizzare il test e ottenere il livello FTP.

5.- TEST FTP.-

Dopo aver premuto il tasto  apparirà TEST nella parte superiore dello schermo, Fig.9.

Il test viene eseguito in 3 fasi:
 Fase 1: riscaldamento di 2 minuti.
 Fase 2: prova di 14 minuti.
 Fase 3: Sprint di 4 minuti.
 Durante gli ultimi 10 secondi di ogni fase, la parola TEST e la durata lampeggieranno.

Una volta concluso il test apparirà sullo schermo il valore FTP, Fig.10.

Il valore FTP (Functional Threshold Power) corrisponde con la potenza che l'utente può esercitare durante 45-60 min. È un buon riferimento per determinare i punti di lavoro in base alla tabella di seguito:

zona	 %
Recupero	<55%
Resistenza	55% – 74%
Ritmo	75% – 89%
Limite lattato	90% – 104%
VO2	105% – 120%
Limite anaerobico	>120%

Se il valore del FTP è 0 le zone determinano le funzione dei watts :

zona	WATT
Recupero	0-99
Resistenza	100-199
Ritmo	200-299
Limite lattato	300-399
VO2	400-499
Limite anaerobico	≥500

6.- CAMBIO UNITÀ DI MISURA.-

Con il monitor acceso premere i tasti  e  durante 3 secondi per accedere alla Fig.11.

Premere il tasto  per confermare e cambiare valore.

Premere i tasti  o  per regolare il valore.



Introdurre l'unità di misura nella parte intermedia (0-> metrico; 1-> inglese).

La parte inferiore mostra la versione del software.

Una volta introdotti i valori, premere

il tasto  durante 3 secondi per salvare la configurazione. Uscire e tornare alla schermata iniziale.

7.- INTRODUZIONE DEI DATI.-

Premere i tasti  e  durante 3 secondi per accedere alla Fig.12.

Premere il tasto  per confermare e cambiare il valore.

Premere i tasti  o  per impostare il valore.

Impostare l'età nella parte superiore. Introdurre il valore FTP ottenuto, nella parte intermedia. (0 se desidera lavorare con Watts) Introdurre il peso nella parte inferiore.

FUNZIONAMENTO iOS (iPod Touch/iPhone/iPad).-

Questo monitor dispone di un modulo Bluetooth integrato.

Scaricare una App compatibile con il protocollo FTMS (ZWIFT, KINOMAP,...) dall' App Store.

Attivate la funzione Bluetooth dell' iPod/iPhone/iPad in modo da attivare la ricerca dei dispositivi Bluetooth automaticamente. Aprire l'App per iniziare. Quando verrà riconosciuto dall'applicazione, selezionare il corretto modulo BH dall'elenco sul display del vostro dispositivo per collegare i due sistemi.

FUNZIONAMENTO DISPOSITIVI ANDROID.-

Questo monitor dispone di un modulo Bluetooth integrato.

Scaricare una App compatibile con il protocollo FTMS (ZWIFT, KINOMAP,...) da Google Play. Attivate la funzione Bluetooth del dispositivo Android e aprire l'App. Quando verrà riconosciuto dall'applicazione, selezionare il corretto modulo BH dall'elenco sul display del vostro dispositivo Android per collegare i due sistemi.

Nota: il monitor deve essere acceso per potersi connettere.

Pedalare e premere il tasto  per iniziare l'esercizio.

Vedi le app compatibili sul Web:
www.bhfitness.com

Otteni il tuo codice di attivazione BH gratuito Kinomap all'indirizzo:
<http://colectivos.bhonlinestore.com/bh-by-kinomap/>

Per qualsiasi domanda, non esitate a mettervi in contatto con il Servizio di Assistenza Tecnica, chiamando al telefono di attenzione al cliente (consultare l'ultima pagina del presente manuale).

BH SI RISERVA IL DIRITTO DI MODIFICARE LE SPECIFICAZIONI DEI SUOI PRODOTTI SENZA PREVIO AVVISO.

BH FITNESS SPAIN

EXERCYCLE, S.L.
(Manufacturer)
P.O. BOX 195
01080 VITORIA (SPAIN)
Tel.: +34 945 29 02 58
Fax: +34 945 29 00 49
e-mail: bhpro@bhfitness.com
www.bhfitness.com

POST-VENTA

Tel: +34 945 292 012
e-mail:
asistencia@bhfitness.com

BH FITNESS PORTUGAL

Rua do Caminho Branco Lote 8,
ZI Oia 3770-068 Oia
Oliveira do Bairro (PORTUGAL)
Tel.: +351 234 729 510
e-mail: info@bhfitness.pt

BH SERVICE PORTUGAL

Tel.: +351 234 729 510
e-mail: info@bhfitness.pt

BH FITNESS FRANCE

SAV FRANCE
Tel : +33 559 423 419
savfrance@bhfitness.com

BH FITNESS UK

Tel: 02037347554
e-mail: sales.uk@bhfitness.com

AFTER SALES – UK

Tel.: 02074425525
e-mail:
service.uk@bhfitness.com

BH Germany GmbH

Grasstrasse 13
45356 ESSEN
GERMANY

Tel: +49 2015 997018
e-mail:
kundendienst@bhgermany.com

BH FITNESS MEXICO

BH Exercycle de México
S.A. de CV
Eje 132 / 136
Zona Industrial, 2A Secc.
78395 San Luis Potosí
S:L:P: MÉXICO
Tel.: +52 (444) 824 00 29
Fax: +52 (444) 824 00 31
www.bh.com.mx

BH FITNESS ASIA

BH Asia Ltd.
No.80, Jhongshan Rd.,
Daya Dist.,
Taichung City 42841,
Taiwan. R.O.C.
Tel.: +886 4 25609200
Fax: +886 4 25609280
E-mail:
info@bhasia.com.tw

ESESSTNI

BH SE RESERVA EL DERECHO A MODIFICAR LAS ESPECIFICACIONES DE SUS PRODUCTOS SIN PREVIO AVISO.

SPECIFICATIONS MAY BE CHANGED WITHOUT PRIOR NOTICE DUE TO OUR PROGRAMME OF CONTINUOUS PRODUCT DEVELOPMENT.

BH SE RÉSERVE LE DROIT DE MODIFIER LES SPECIFICATIONS DE SES PRODUITS SANS PRÉAVIS.

BH BEHALT SICH DAS RECHT VOR, ÄNDERUNGEN DER MODELL-ANGABEN OHRE VORHERIGE ANKÜNDIGUNG VORZUNEHMEN.

DATI TECNICI E COMMERCIALI RELATIVI AGLI ARTICOLI DEL PRESENTE CATALOGO POSSONO ESSERE SOGGETTI A VARIAZIONI SENZA ALCUN PREAVVISO.

BH FITNESS RESERVA O DIREITO DE PODER MODIFICAR AS ESPECIFICAÇÕES DOS SEUS EQUIPAMENTOS SEM AVISO PRÉVIO.

DOOR KONSTANTE PRODUKTVERNIEUWING EN VERBETERING HOUDEN WIJ ONS HET RECHT VAN WIJZIGING VOOR ZONDER VOORAFGAAND BERICHT.